

Percussion Hammers and Aesthesiometers
Reflexhammer und Sensibilitätsinstrumente



01-101
TROEMNER
 Size: 245 mm



01-102
DEJERINE
 Size: 200 mm



01-103
DEJERINE
 with needle
 Size: 210 mm



01-104
TAYLOR
 Size: 195 mm



01-105
BERLINER
 Size: 200 mm



01-106
BUCK
 with needle
 and brush
 Size: 180 mm



01-107
RABINER
 with needle
 and brush
 Size: 255 mm



01-108
ALY
 Size: 190 mm



01-109
WARTENBERG
 Pinwheel for
 neurological
 examination
 Size: 185 mm

Stethoscopes
Stethoskope



01-110
PINARD (Aluminum)
Size: 155 mm

1/2



01-111
wooden
Size: 145 mm

1/2



01-112
BOWLES
Stethoscope
with diaphragm

1/4



01-113
ANESTOPHON

1/2



01-114
FORD-BOWLES
Dual chest piece
with two outlets

1/4



01-115
BOWLES

1/4

Head Mirrors and Head Bands Reflexspiegel und Stirnbänder



01-116
ZIEGLER Ø 90mm
head mirror only
with rubber coating

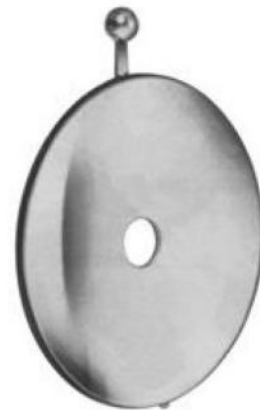

01-117
ZIEGLER Ø 90mm
head mirror only
with metal coating



01-118
ZIEGLER
head band of plastic black

01-119
ZIEGLER
head band of plastic white



01-120
MURPHY
head band of celluloid, white



01-121
head band of plastic,
white, soft pattern



01-122
head mirror with black
plastic head band.

Tongue Depressors Zungenspatel

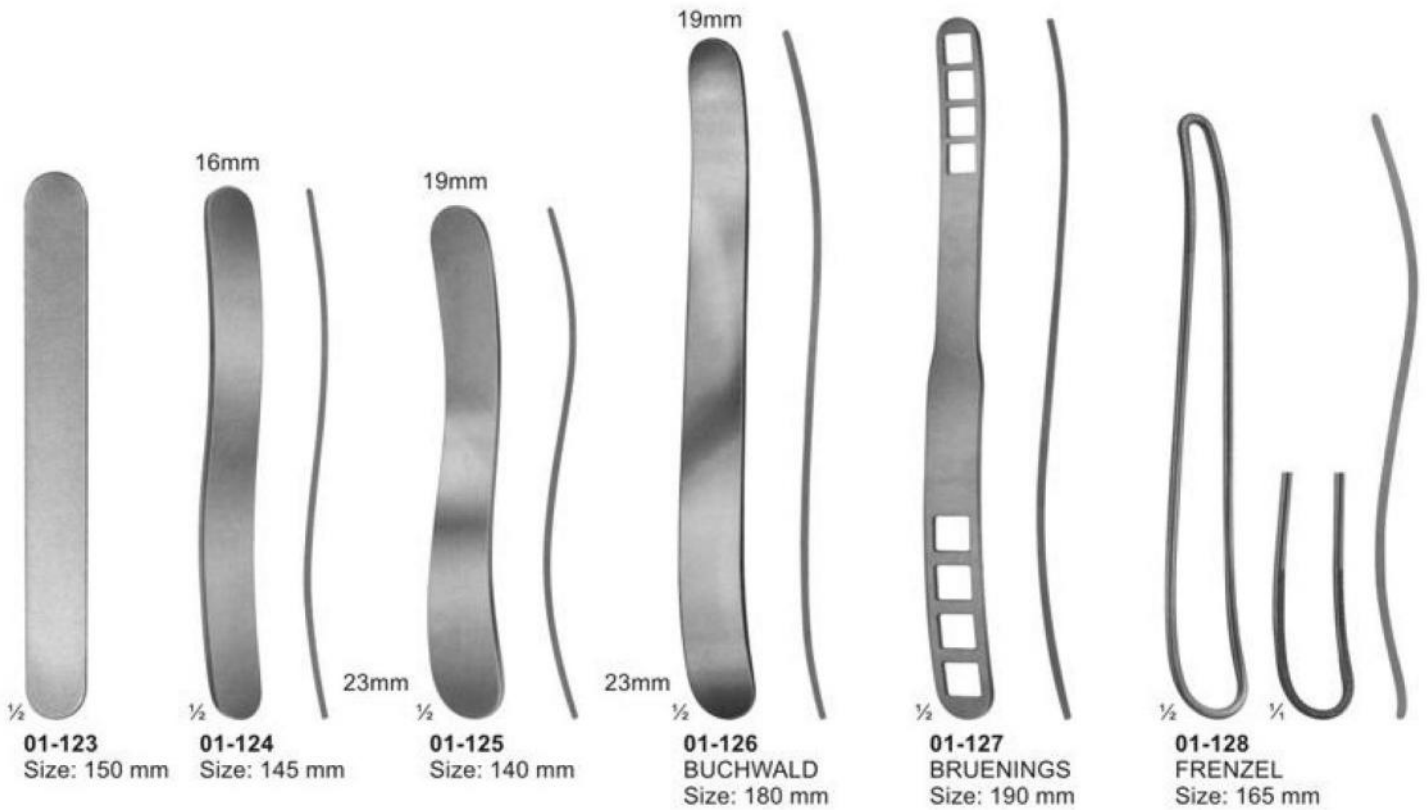



1/2
01-134
 SCHIMMELBUSCH
 Ether mask



1/2
01-135
 HEISTER
 Mouth gag
 Size: 130 mm



1/2
01-136
 FERGUSSON-ACKLAND
 Mouth gag
 Size: 145 mm



1/2
01-137
 DENHARDT
 Mouth gag with silicon
 inserts, interchangeable
 Size: 125 mm



1/2
01-138
 ROSER KOENIG
 Mouth gag
 Size: 160 mm, 185 mm

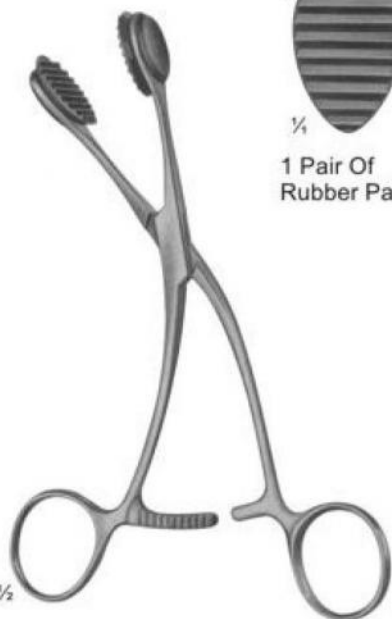

1/2
01-139
 YOUNG
 Size: 165 mm



1/4
 1 Pair Of
 Rubber Pads

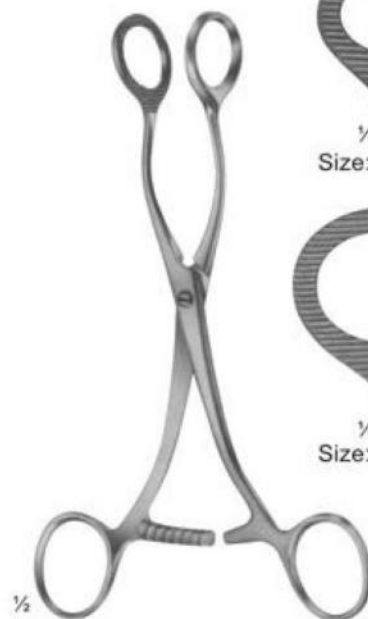

1/2
01-140
 COLLIN
 Size: 160 mm, 170 mm



1/4
 Size: 160 mm



1/4
 Size: 170 mm

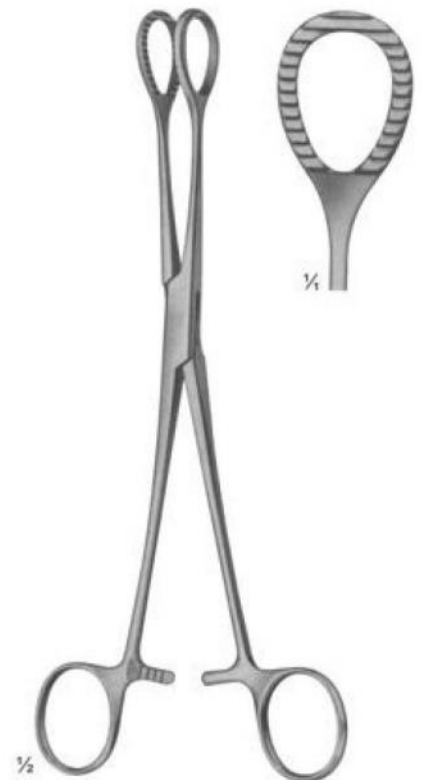

1/2
01-141
 HEYWOOD-SMITH modif.
 Size: 215 mm

Blood Lancets and Laryngeal Mirrors Blutentnahmenadeln und Kehlkopfspiegel



01-142
FRANCKE
Automatic blood lancet

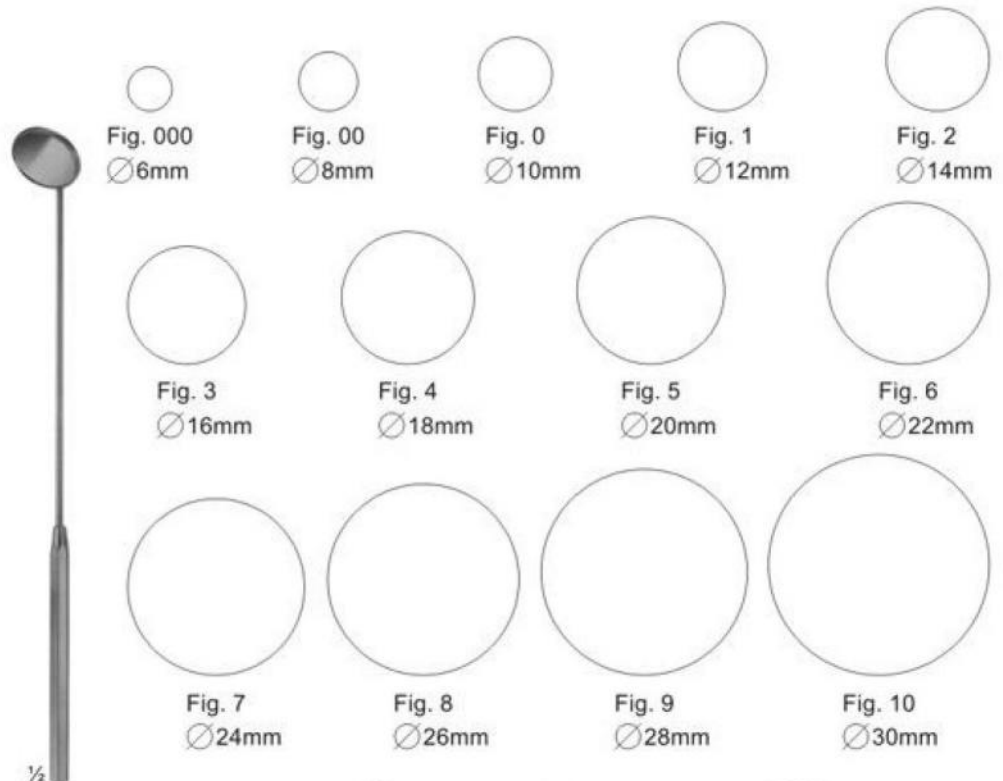

01-143
Laryngeal mirrors with
hexagonal handle
Size: 180 mm



01-148
Spare mirrors only
Size: 12 mm

01-149
Spare mirrors only
Size: 14 mm



01-144
KOLLE
Microscopic Needle
Holder with plastic handle
Size: 240 mm



01-145
Mirror handle
Size: 110 mm



01-146
Mirror handle
Size: 105 mm



01-147
MICHEL
Rhinoscopic mirrors with
interchangeable mirror inserts
Size: 250 mm

Laryngoscope and Diagnostic Sets

Laryngoskope und Diagnostikbestecke



1/2

01-150 - 152
MAGILL



1/4

01-150
Infants
Size: 150 mm



1/4

01-151
Children
Size: 200 mm



1/4

01-152
Adults
Size: 250 mm



1/2

01-153
Medium battery handle
only, 25 mm diam.



01-153-A
Spare bulb
2.7 volt, for
otoscopes



01-153-B
Spare bulb
2.6 volt, for
ophthalmoscopes



01-154
Otoscope set, consists of
battery handle without batteries,
3 ear specula, 1 bulb in velvet lined case



01-155
Diagnostic set, otoscope with three specula,
nasal speculum, lamp holder, two laryngeal
mirrors, tongue blade holder

Laryngoscopes Laryngoskope



01-156
MILLER
Laryngoscope set, consists of battery handle (without battery)
with four miller laryngoscope blades

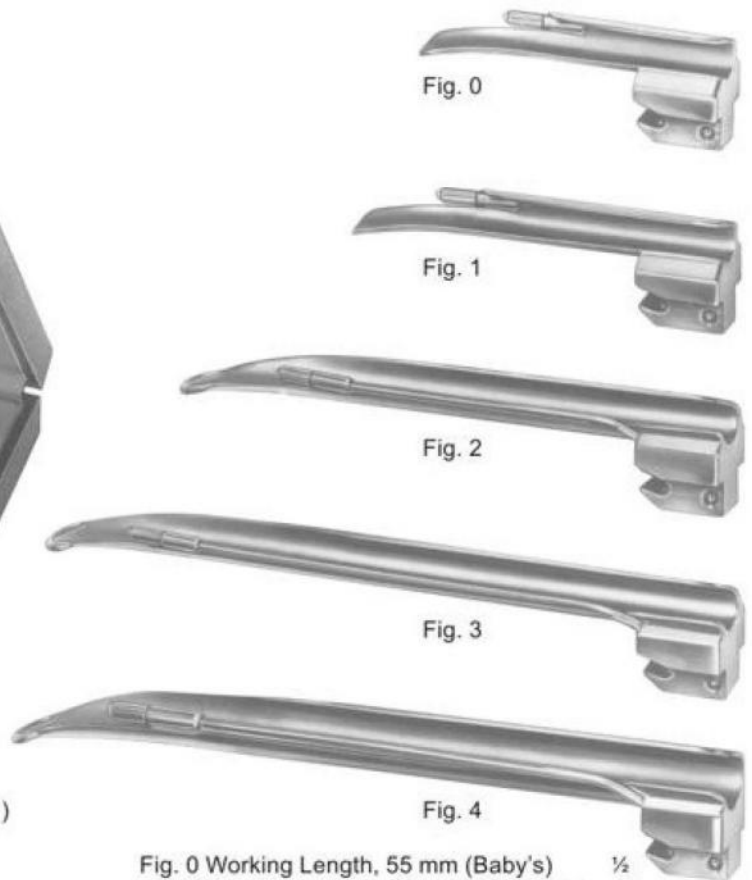

Fig. 0 Working Length, 55 mm (Baby's) $\frac{1}{2}$
Fig. 1 Working Length, 80 mm (Children's)
Fig. 2 Working Length, 130 mm (Adolescent's)
Fig. 3 Working Length, 170 mm (Women's)
Fig. 4 Working Length, 180 mm (Men's)



01-157
GUEDEL-NEGUS
Laryngoscope set, consists of battery handle (without battery)
with four miller laryngoscope blades



Fig. 1 Working Length, 70 mm (Children's) $\frac{1}{2}$
Fig. 2 Working Length, 90 mm (Adolescent's)
Fig. 3 Working Length, 110 mm (Women's)
Fig. 4 Working Length, 135 mm (Men's)



02-101 - 110
Fig. 1 - 10



02-101
Fig. 1
30 mm



02-102
Fig. 2
36 mm



02-103
Fig. 3
40 mm



02-104
Fig. 4
45 mm



02-105
Fig. 5
50 mm



02-106
Fig. 6
27 mm



02-107
Fig. 7
35 mm



02-108
Fig. 8
40 mm



02-109
Fig. 9
47 mm



02-110
Fig. 10
50 mm



LISTON
02-111
 Size: 130 mm
02-112
 Size: 160 mm
02-113
 Size: 190 mm
02-114
 Size: 200 mm

02-115
CATLIN
 Size: 160 mm
 Blade length
 Amputating
 Knives

02-116
LANGENBECK
 Size: 120 mm
 Blade length
 Flap Knives

02-117
 Size: 110 mm
 Blade length
 Interosseous
 Knives

02-118
 Size: 55 mm
 Blade length
 with raspatory,
 Wooden handle

02-119
 Size: 70 mm
 Blade length
 Wooden handle

02-120
 Size: 80 mm
 Blade length
 Metal handle

02-121
 Size: 195 mm
 Blade length
 Metal handle

Blade length
 Amputating Knives

Cone Knives, Myomatome, Trigeminal and Tonsil Knife
Konisationsmesser, Myommesser, Trigeminal und
Tonsillenmesser



02-122
 AYRE
 Size: 235 mm
 Cone Knife

02-123
 Size: 230 mm
 Cone Knife

02-124
 SEGOND
 Size: 270 mm
 Myomatome

02-125
 OLIVECRONA
 Size: 205 mm
 Trigeminal
 Knife

02-126
 Size: 230 mm
 Trigeminal
 Knife

02-127
 FOWLER
 Size: 200 mm
 Tonsil Knife

02-128
 ABRAHAM
 Size: 215 mm
 Tonsil Knife

02-129
 BRUNINGS
 Size: 215 mm
 Tonsil Knife

Scalpel Handles Skalpelli



02-130
STANDARD
No. 3
Solid
12 cm

02-131
No. 3
Solid
12 cm

02-132
No. 3
Solid
12 cm

02-133
No. 3 L
Straight
Solid
21.5 cm

02-134
No. 3 L
Angled
Solid
21 cm

02-135
No. 7
Solid
16 cm

02-136
No. 7 K
Solid
12.5 cm

02-137
Hollow-Round
15.5 cm

02-138
No. 3
Straight
Solid,
Round
14.5 cm

02-139
No. 3
Angled
Solid,
Round
14 cm

Micro Scissors (Spring Type) with Flat Handles
Mikro-Federscheren mit Flachgriffen

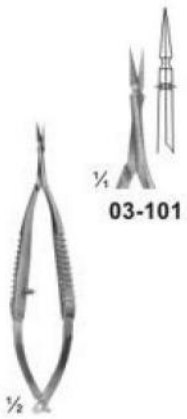

03-101 - 103
VANNAS
 Size: 85 mm



03-104 - 105
CASTROVIEJO
 Size: 95 mm



03-105



03-106
NOYES
 Size: 125 mm



03-107 - 108
WECKER
 Eye scissor
 Size: 110 mm



03-109
CASTROVIEJO
 Eye scissor
 Size: 115 mm



03-110 - 111
CASTROVIEJO
 Eye scissor
 Size: 110 mm

03-110

03-111

Micro Scissors (Spring Type) with Flat Handles Mikro-Federscheren mit Flachgriffen

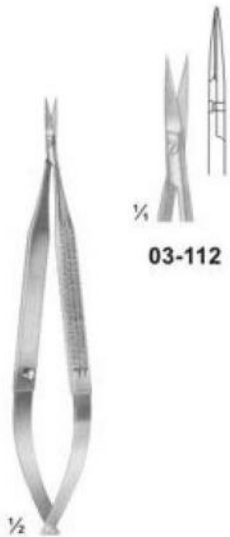

03-112 - 113
Size: 120 mm



03-112



03-113



03-114
BIEMER
Vein scissor
Size: 130 mm



03-115
Size: 160 mm

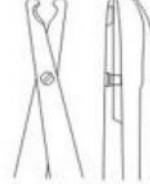

03-116 - 117
VANNAS
Size: 160 mm



03-116



03-117

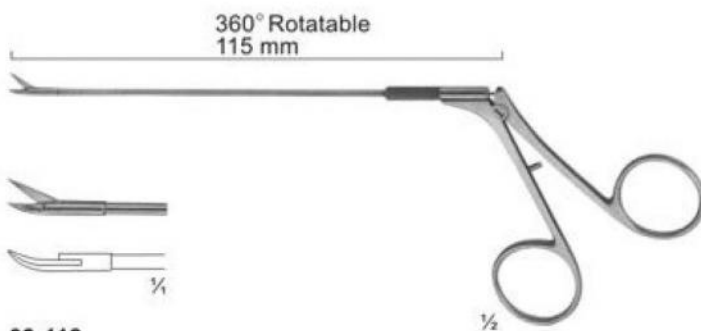

03-118
CASPAR
Micro scissor curved
Size: 115 mm

360° Rotatable
115 mm



03-119



03-120



03-121



03-119 - 121
Micro dissecting scissor
Size: 145 mm

Micro Scissors (Spring Type) bayonet-Shaped
Mikro-Federschere, bajonettformig



03-122
 YASARGIL
 Size: 245 mm



03-123
 45°



03-124
 45°



125°



03-125
 laterally angled
 Size: 190 mm

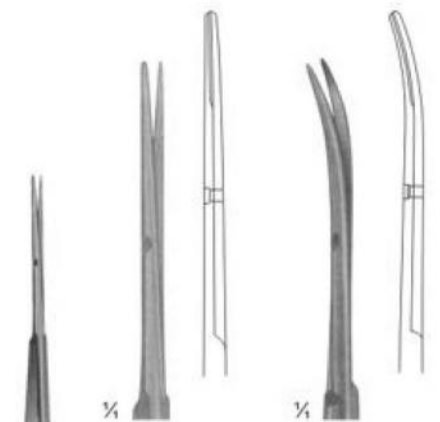

03-126

03-127



03-126 - 127
 YASARGIL
 Size: 225 mm

**Delicate Scissors
Feine Scheren**

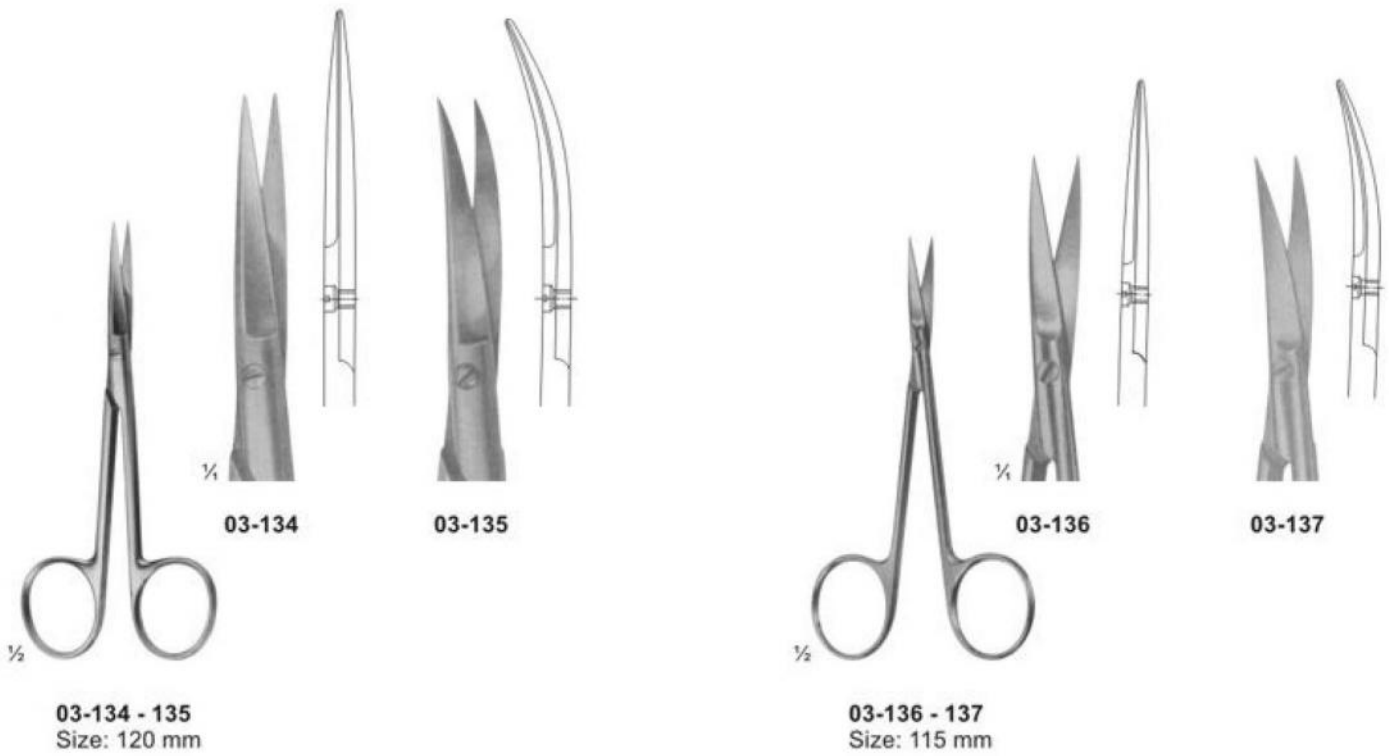
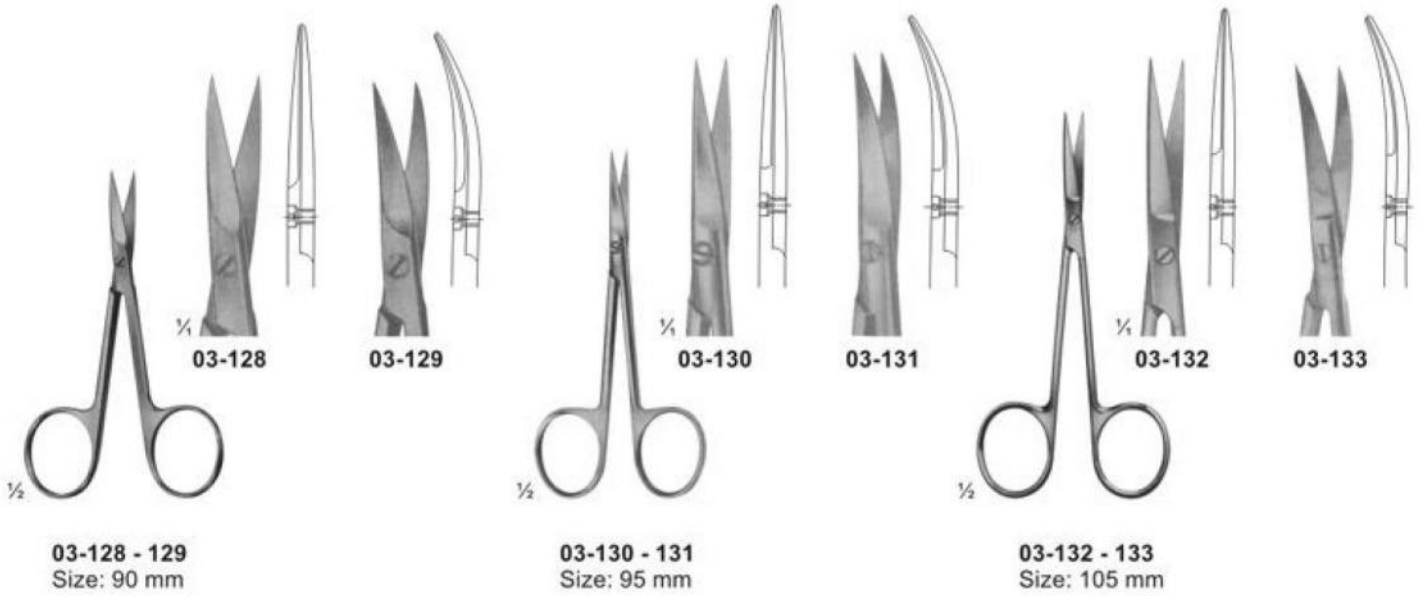

**Delicate Scissors
Feine Scheren**



03-138 - 140
Size: 120 mm



03-138

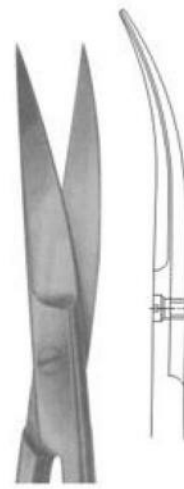

03-139



03-140



03-141 - 144
Size: 130 mm

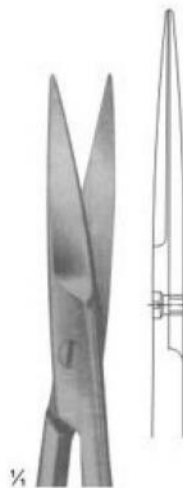

03-141

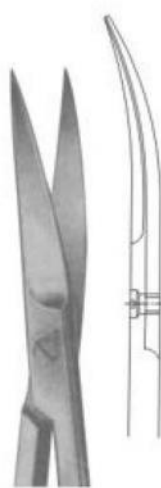

03-142



03-143

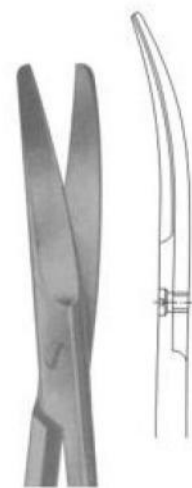

03-144





03-145 - 153 (Standard types)
03-145 (105 mm)
03-146 (115 mm)
03-147 (130 mm)
03-148 (145 mm)
03-149 (150 mm)
03-150 (165 mm)
03-151 (175 mm)
03-152 (185 mm)
03-153 (200 mm)

03-145
Size: 105 mm

03-153
Size: 200 mm



03-154 - 160 (Standard types)
03-154 (115 mm)
03-155 (130 mm)
03-156 (145 mm)
03-157 (150 mm)
03-158 (165 mm)
03-159 (175 mm)
03-160 (185 mm)

03-154
Size: 115 mm

03-160
Size: 185 mm

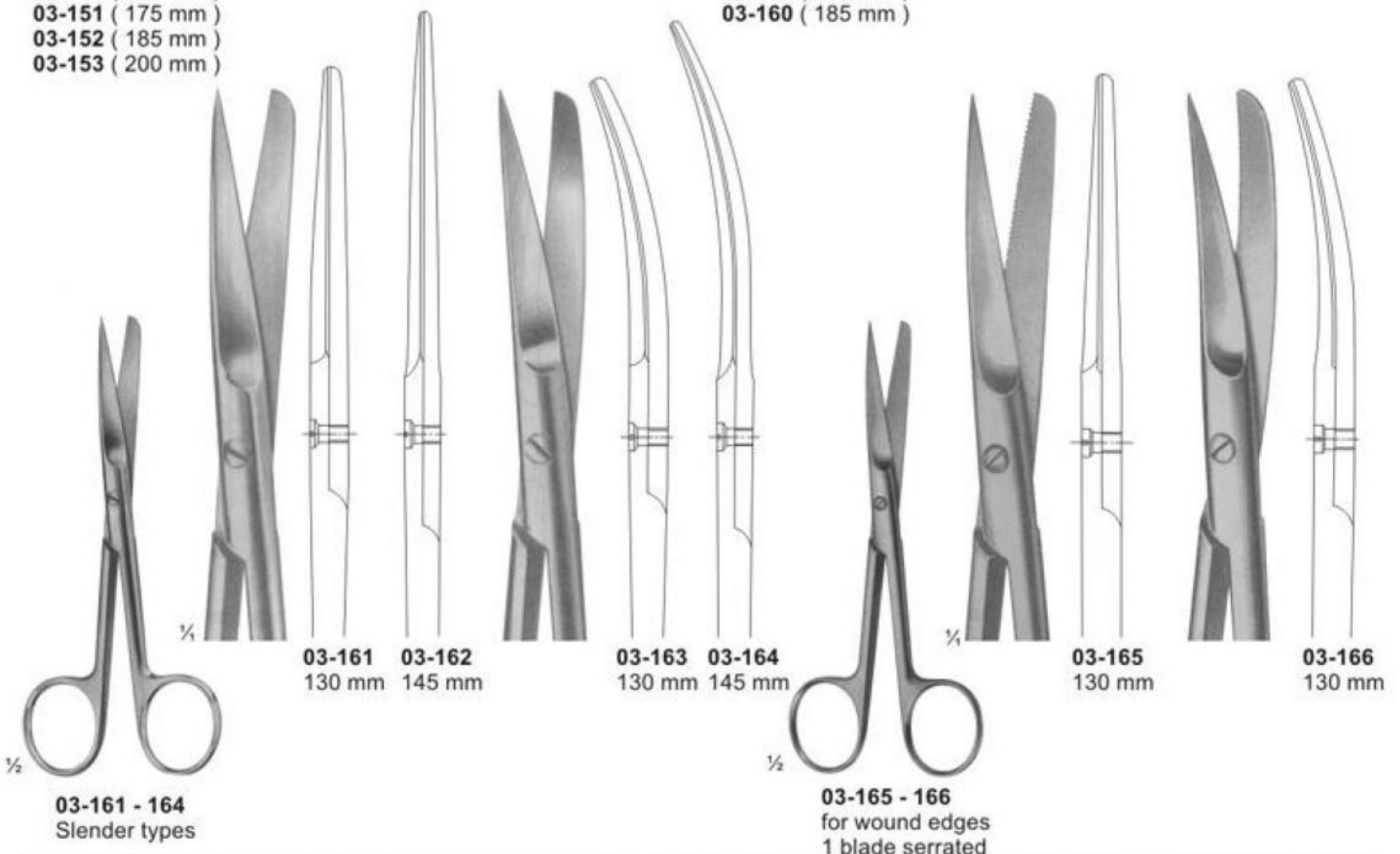

03-161 - 164
Slender types

03-165 - 166
for wound edges
1 blade serrated



03-167 - 169
 DEAVER
 with flat lock

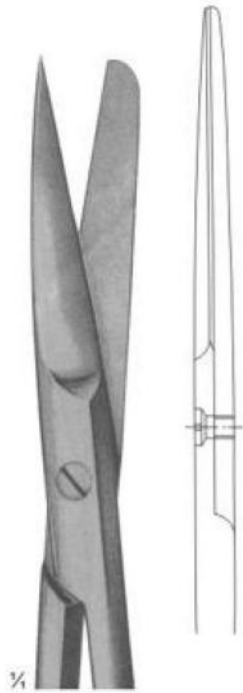

03-167
 Size: 145 mm

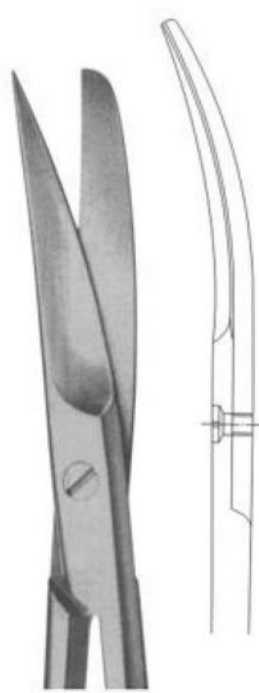

03-168
 Size: 145 mm

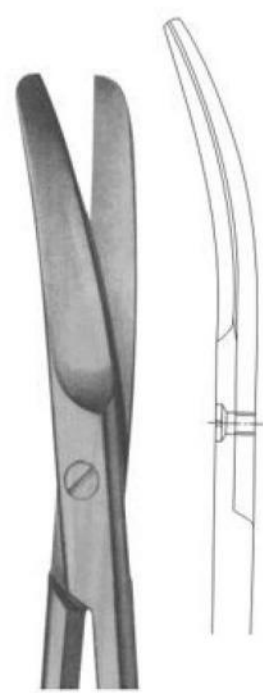

03-169
 Size: 145 mm



03-170 - 172
 Incision scissors

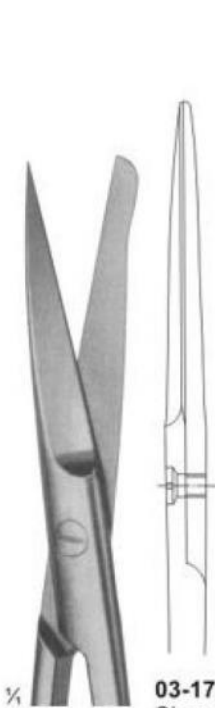

03-170
 Size: 130 mm



03-171
 Size: 145 mm



03-172
 Size: 165 mm



03-173
 SYSTRUNK
 Nail splitting scissors

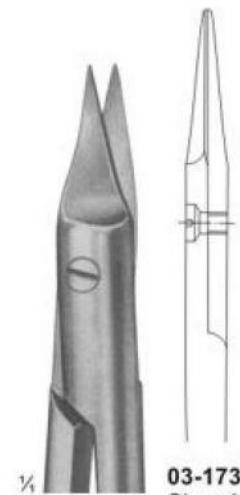

03-173
 Size: 130 mm

Dissecting Scissors Praparierscheren

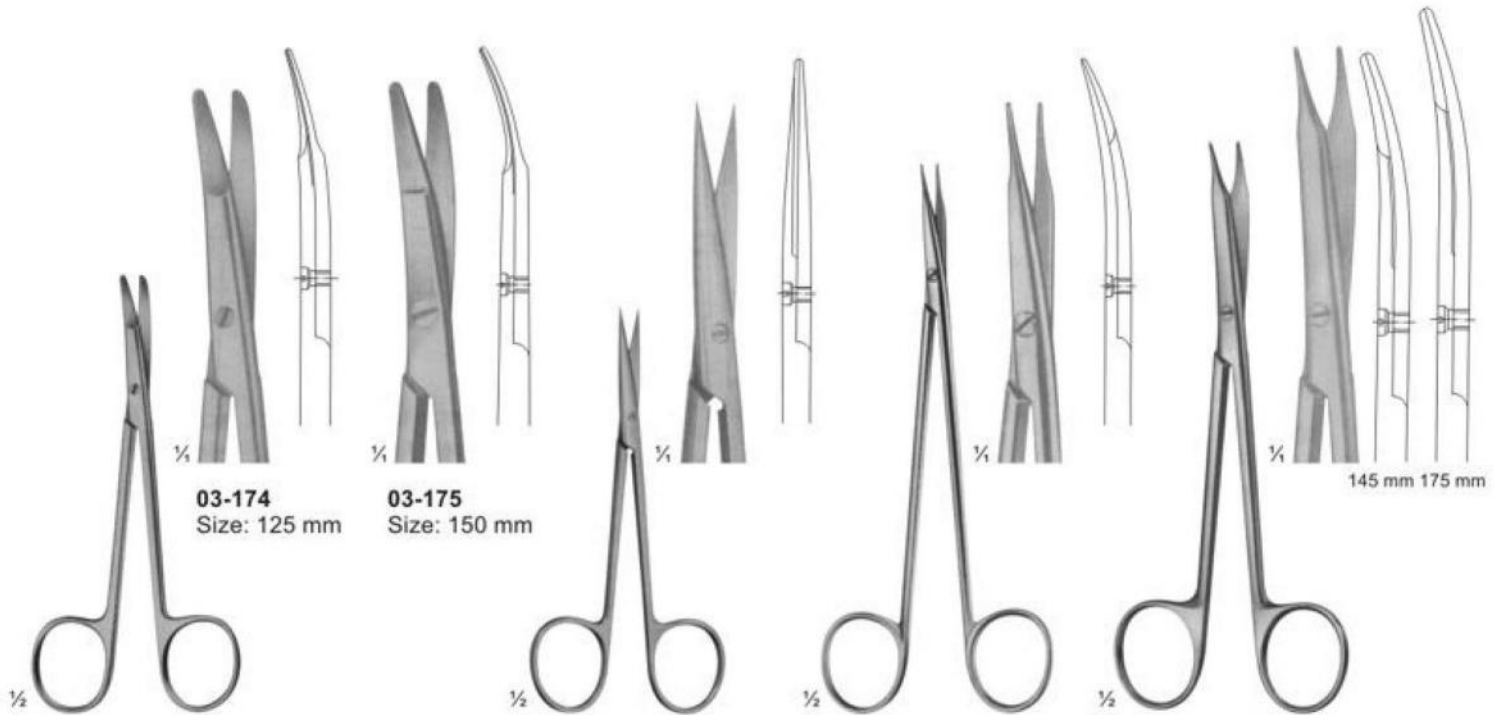

03-174 - 175
KILNER
Special flat points for dissecting
and undermining the skin

03-176
KILNER
Fine dissecting scissors
Size: 115 mm

03-177
JAMESON
Dissecting scissors
Size: 150 mm

03-178
REYNOLDS
Dissecting scissors
Size: 145 - 175 mm

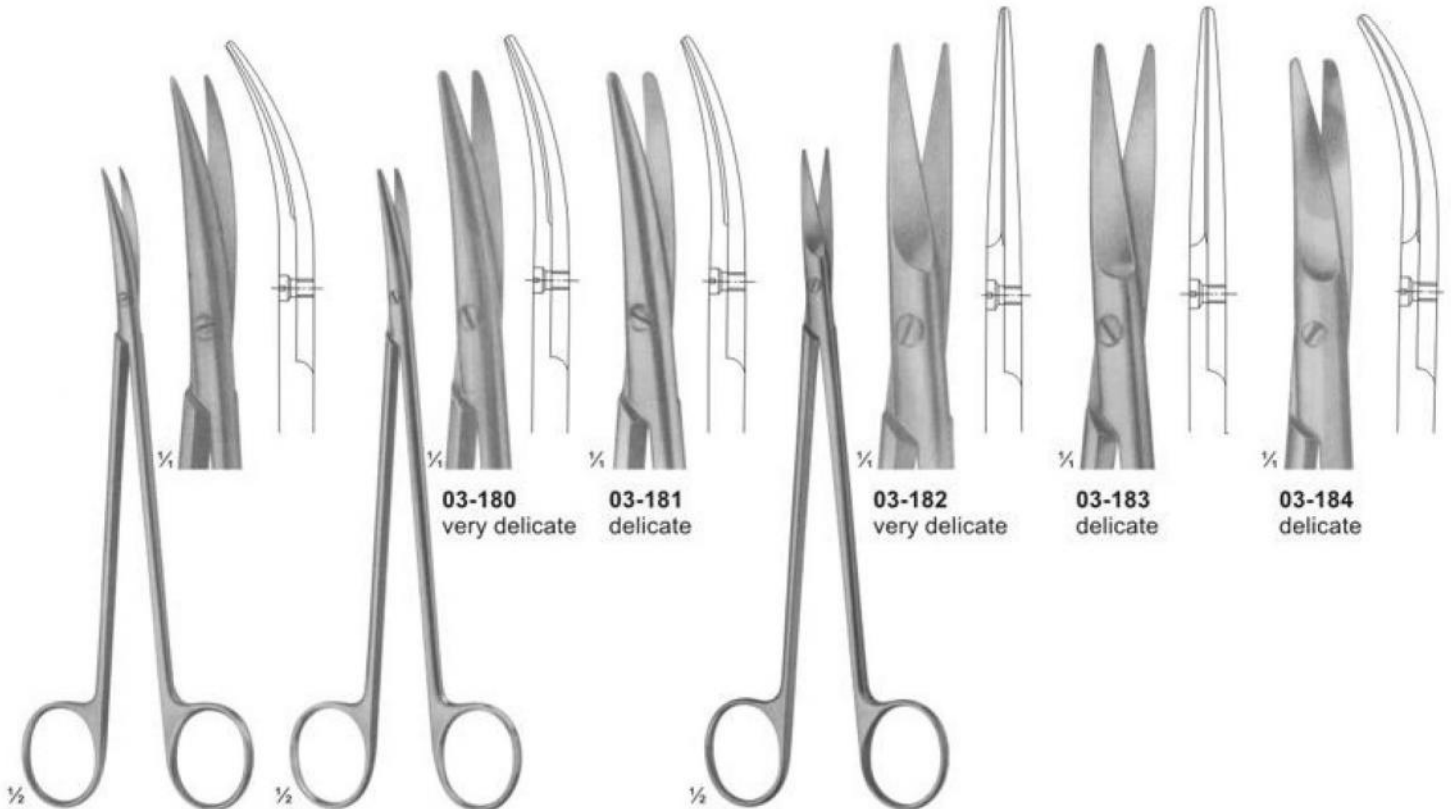

03-179
DE BAKEY
Arteriotomy scissors
Size: 175 mm

03-180 - 181
TOENNIS ADSON
Dissecting scissors
Size: 175 mm

03-182 - 184
TOENNIS
Dissecting scissors
Size: 180 mm

Dissecting Scissors Praparierscheren

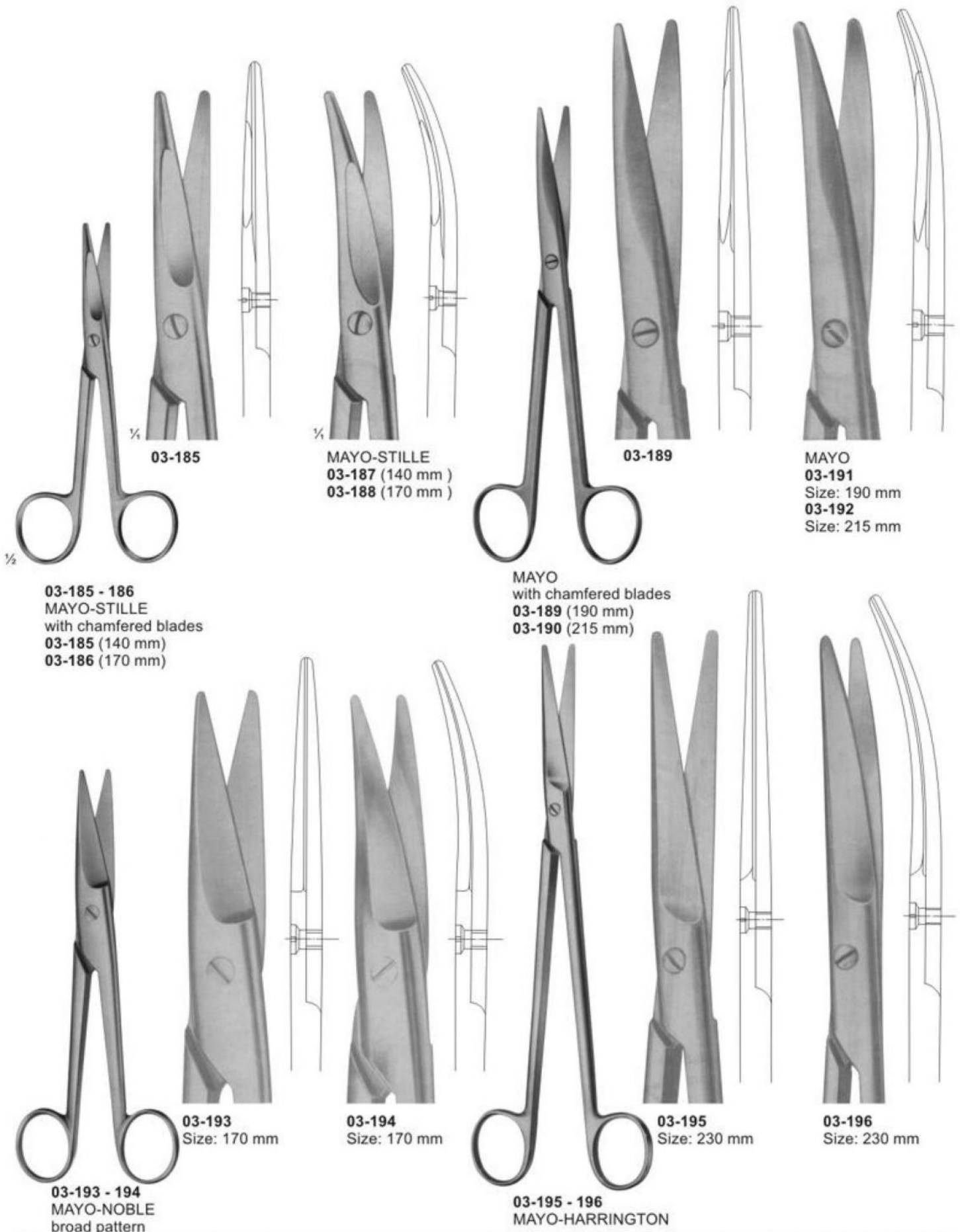

Scissors for Cardiovascular and Neuro-Surgery
Scheren für Herz-, Gefäß- und Neurochirurgie



03-207
OLIVECRONA
 Dura scissors

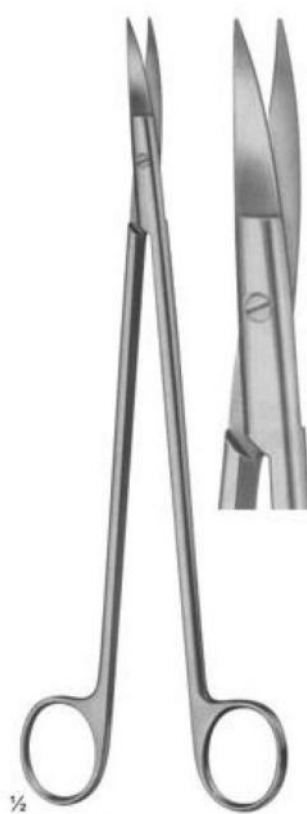

03-208
STRULLY
 pointed
 Size: 220 mm

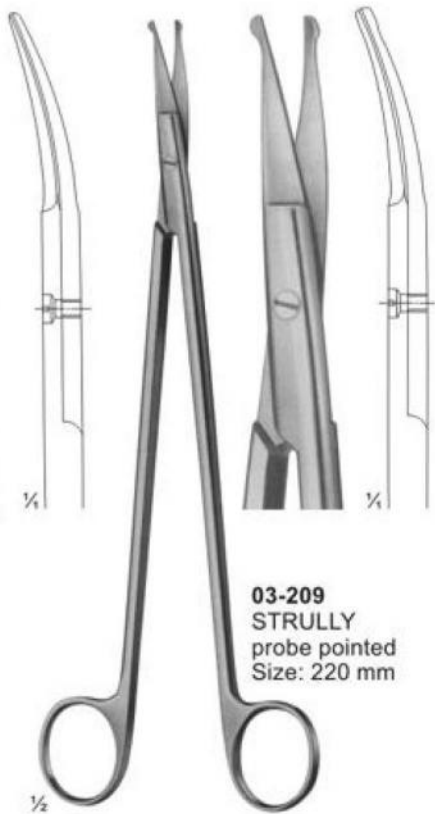

03-209
STRULLY
 probe pointed
 Size: 220 mm

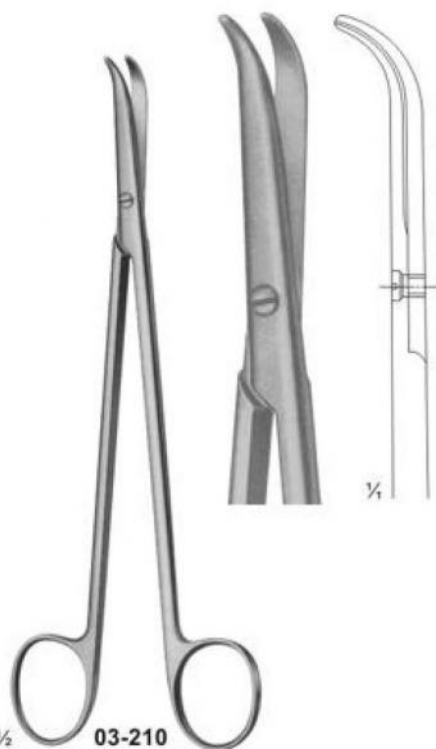

03-210
THOREK
 Size: 180 mm

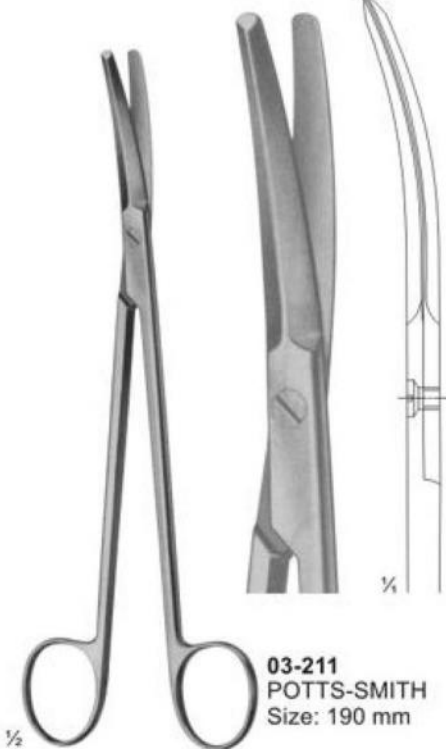

03-211
POTTS-SMITH
 Size: 190 mm

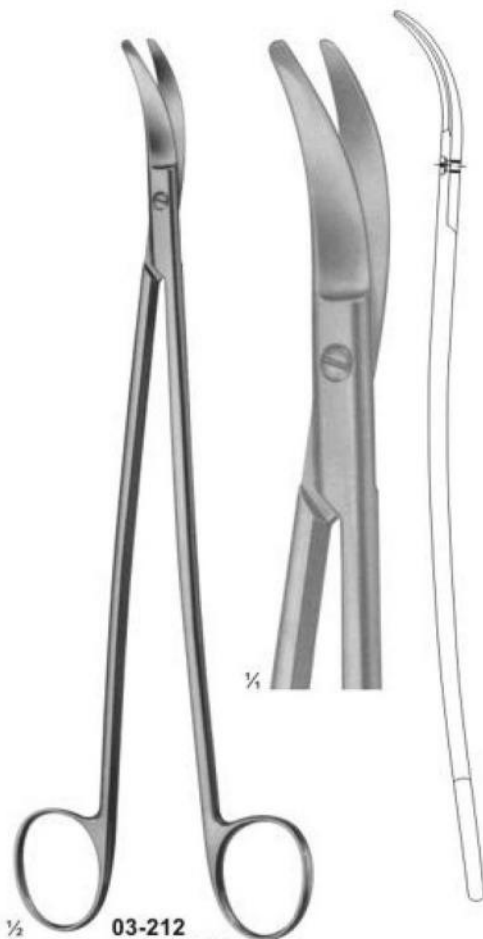

03-212
SATINSKY
 Size: 245 mm

Delicate, Nasal and Tonsil Scissors
Feine, Nasen und Tonsillenscheren

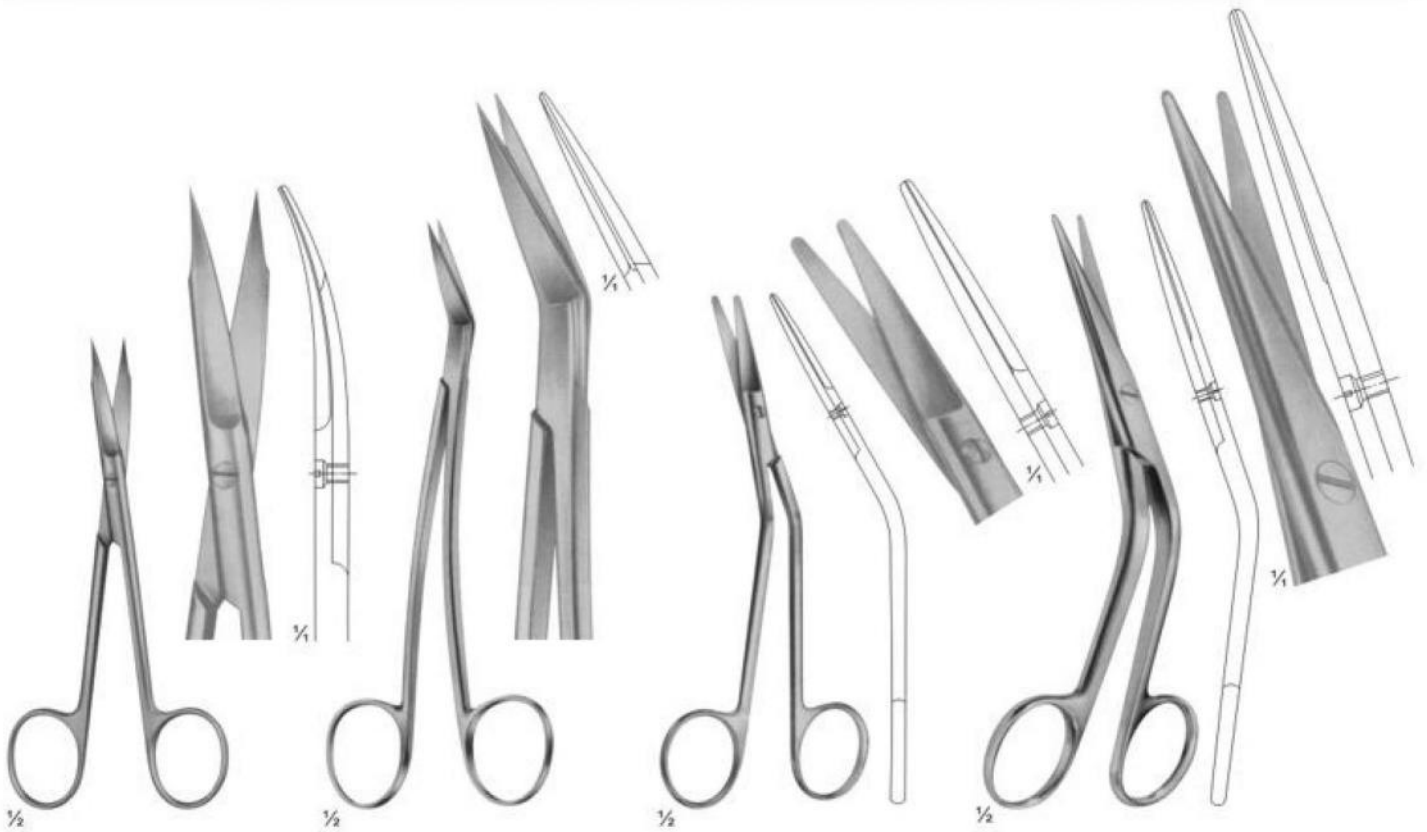

03-213
 1 finely toothed blade
 Size: 130 mm

03-214
 LOCKLIN
 curved sideways,
 1 toothed blade
 Size: 155 mm

03-215
 FOMON
 blades serrated
 Size: 145 mm

03-216
 COTTLE
 Size: 165 mm

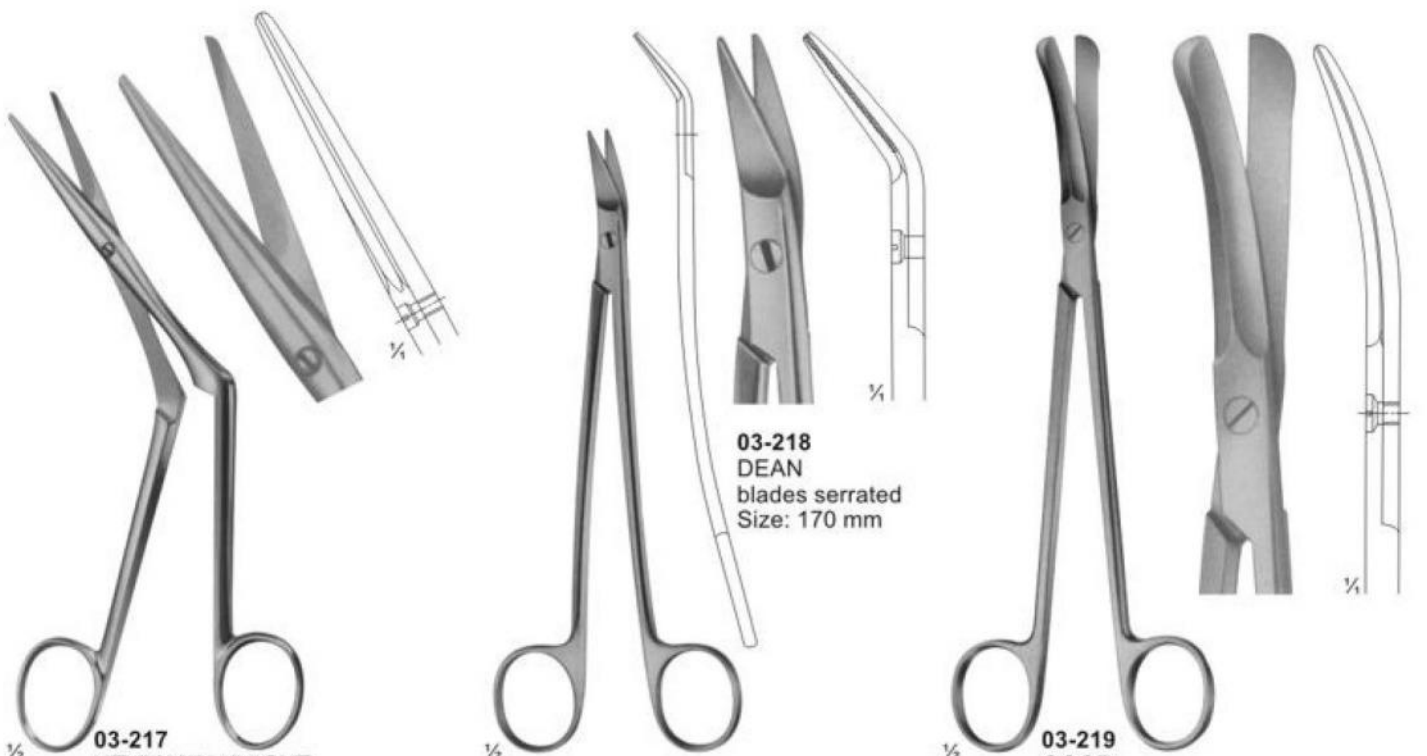

03-217
 HEYMANN-KNIGHT
 Size: 175 mm

03-218
 DEAN
 blades serrated
 Size: 170 mm

03-219
 GOOD
 Size: 195 mm

**Forceps for grasping tissue, tumors etc.
Pinzetten zum Fassen von Gewebe Tumoren usw.**

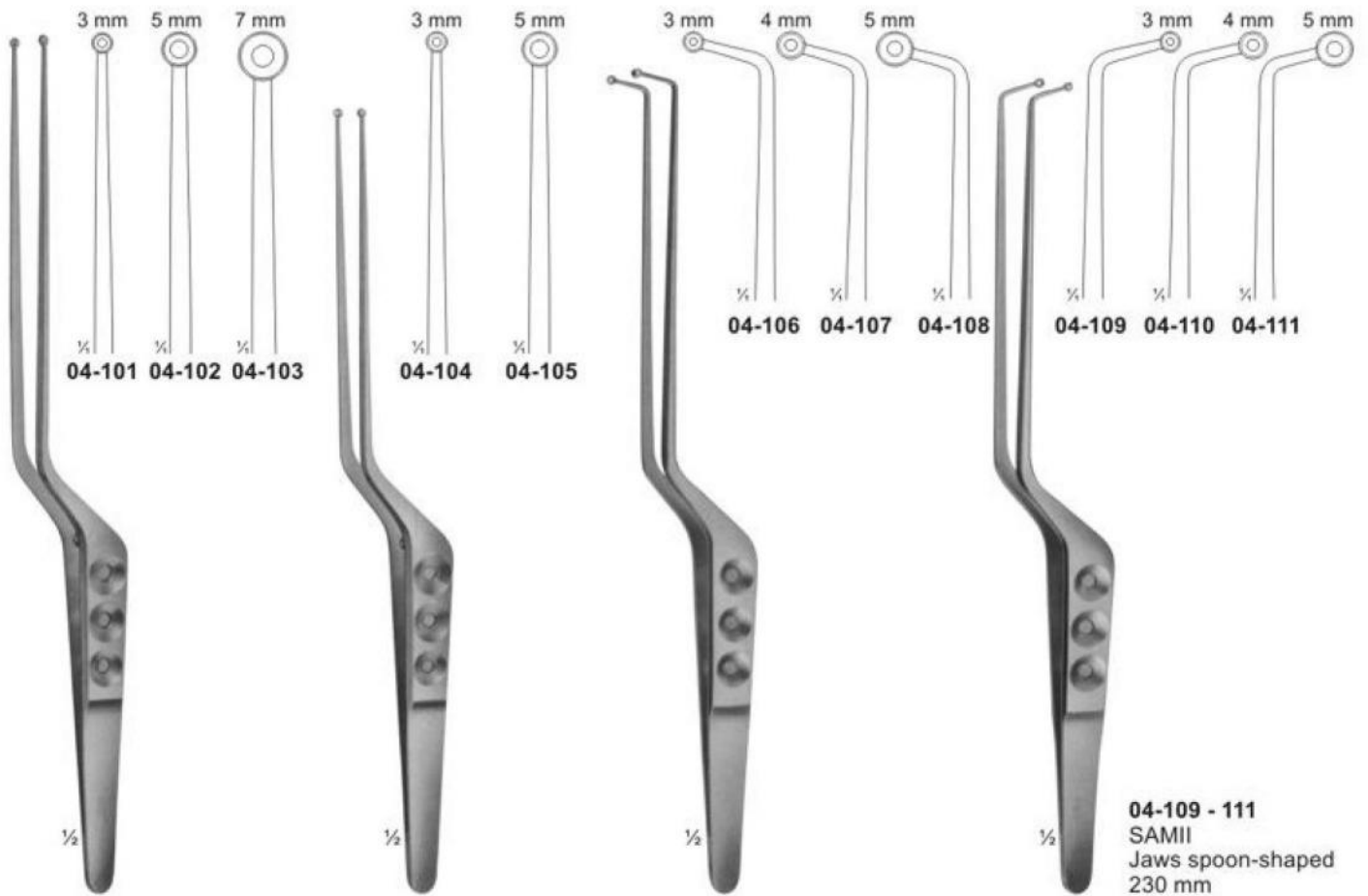

04-101 - 103
YASARGIL-SAMII
Jaws spoon-shaped
240 mm

04-104 - 105
YASARGIL
Jaws spoon-shaped
220 mm

04-106 - 108
SAMII
Jaws spoon-shaped
230 mm

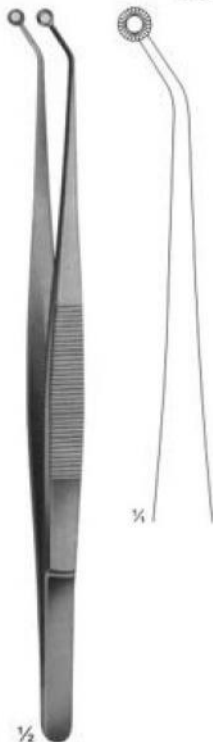

04-112
HUNT
Tumor-and vessel forceps
200 mm



04-113
HUNT
Tumor-and vessel forceps
200 mm



04-114
YASARGIL
Tumor-and vessel forceps
200 mm

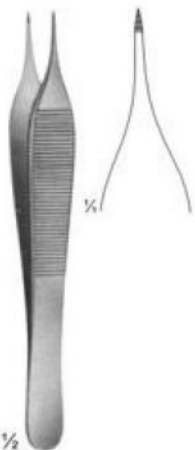

04-115
THORPE
 Corneal forceps
 120 mm



04-116
MICRO-ADSON
 120 mm

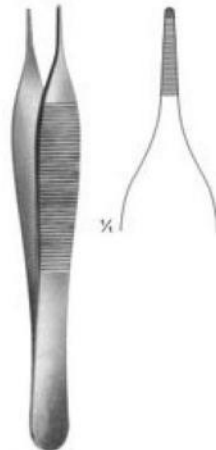

04-117
ADSON
 120 mm



04-118
MICRO-ADSON
 150 mm

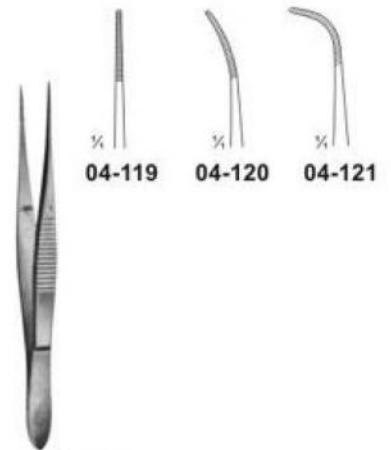

04-119 - 121
 100 mm

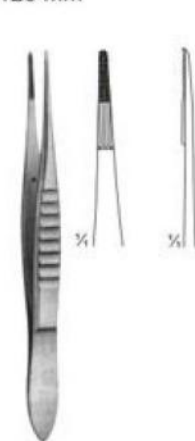

04-122
BONACCOLTO
 110 mm

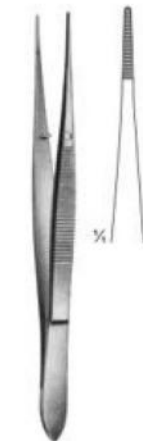

04-123
 115 mm

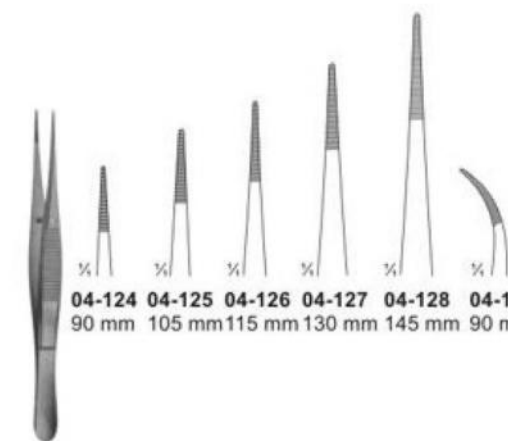

04-124 - 133

04-124 90 mm **04-125** 105 mm **04-126** 115 mm **04-127** 130 mm **04-128** 145 mm **04-129** 90 mm **04-130** 105 mm **04-131** 115 mm **04-132** 130 mm **04-133** 145 mm

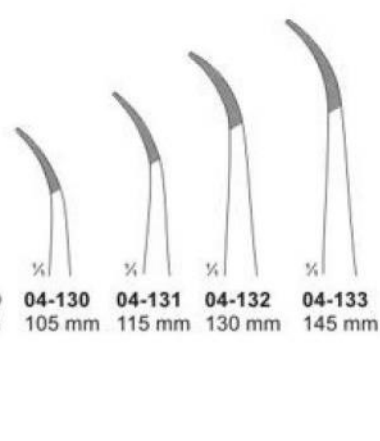

04-134
 100 mm

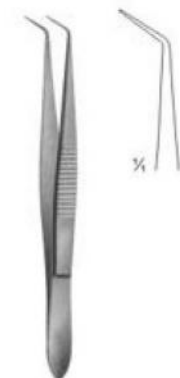

04-135
 100 mm



04-136
 100 mm

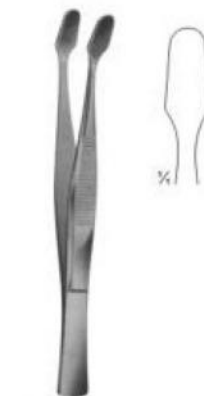

04-137
KUHNE
 Cover glass forceps, 105 mm



04-138
 160 mm

Delicate Dissecting Forceps Feine anatomische Pinzetten

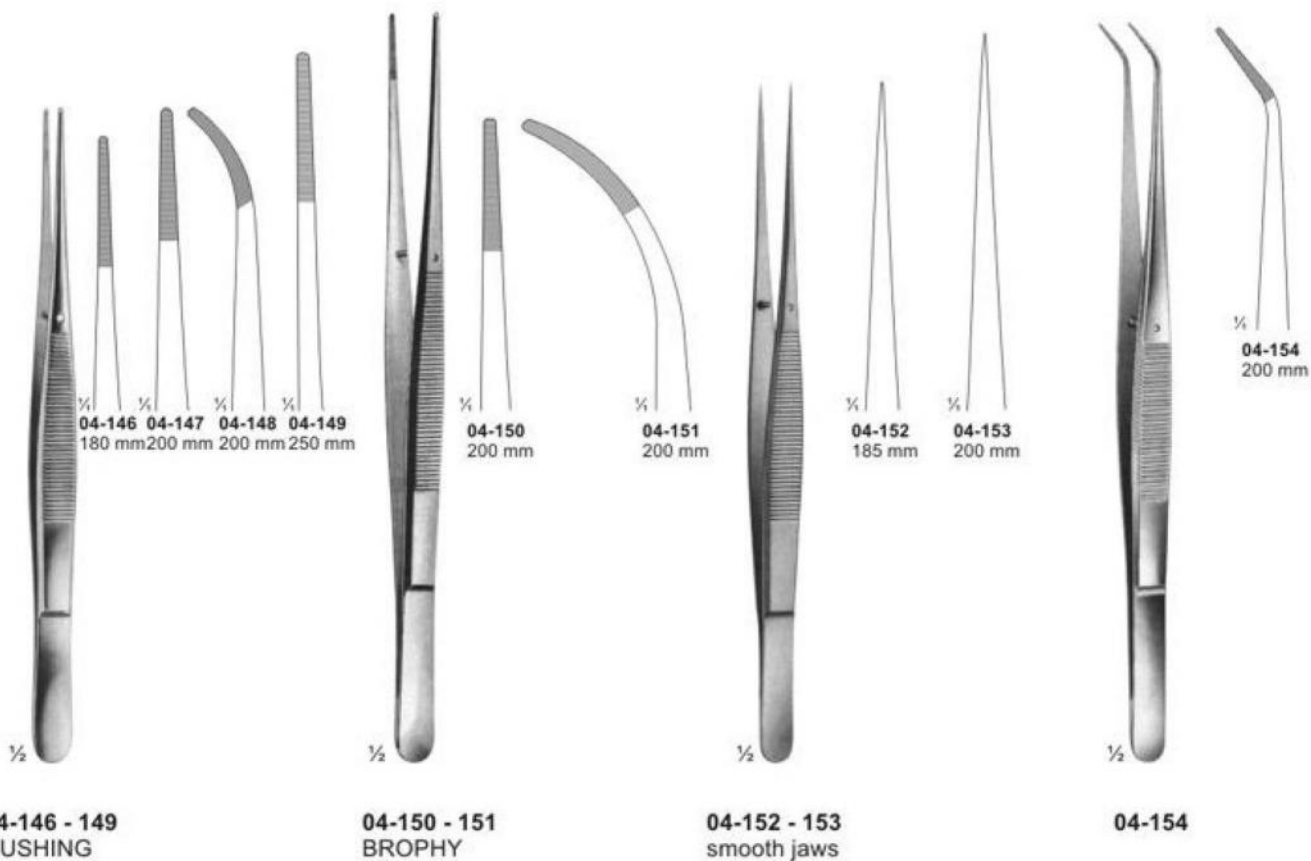
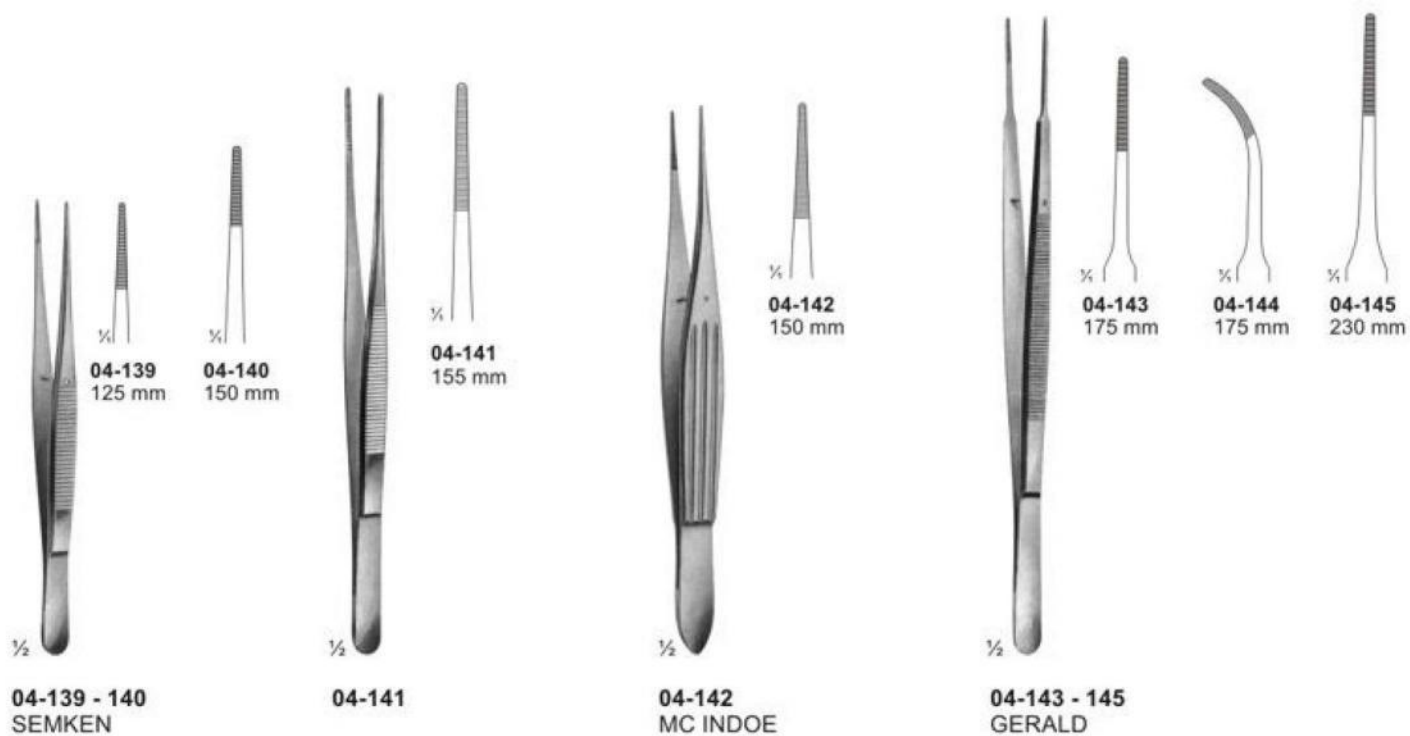

Delicate Tissue Forceps Feine chirurgische Pinzetten

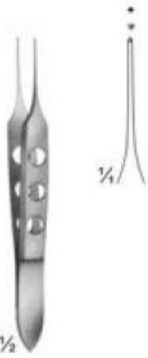

04-170
BISHOP-HARMON
85 mm

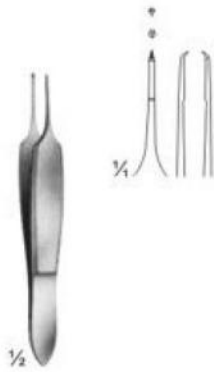

04-171
ST.MARTIN
80 mm

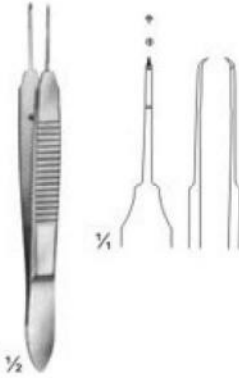

04-172
CASTROVIEJO
teeth 0.9 mm
100 mm

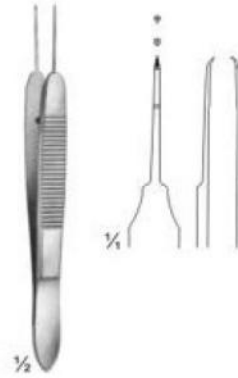

04-173
CASTROVIEJO
teeth 0.5 mm
100 mm

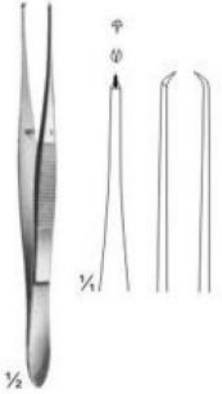

04-174
ELSCHING
110 mm

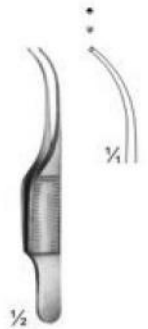

04-175
GILL
75 mm



04-176
GILL - HESS
75 mm

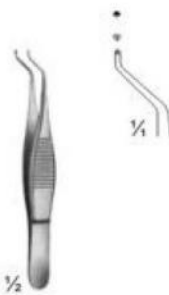

04-177
HESS
70 mm

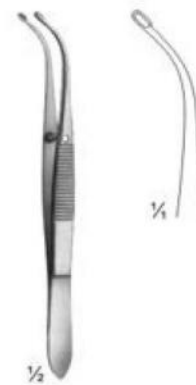

04-178
ARRUGA
100 mm

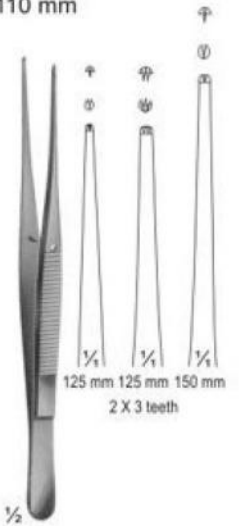

04-179
SEMKEN
125 mm 125 mm 150 mm
2 X 3 teeth



04-180
MICRO-ADSON
120 mm



04-181
ADSON
120 mm

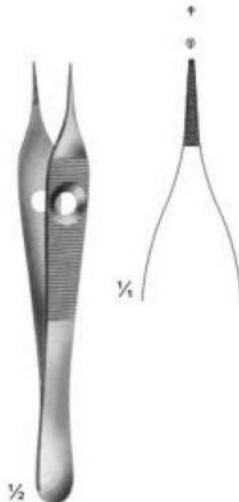

04-182
ADSON
120 mm



04-183
ADSON
120 mm

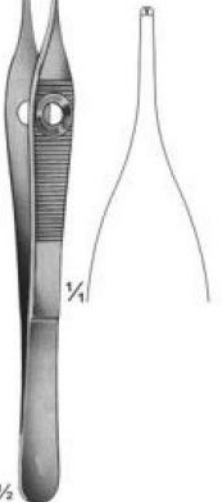

04-184
ADSON
150 mm

Tissue Forceps, Lung Dissecting Forceps
Chirurgische Pinzetten, Lungenfaßpinzetten



Splinter and Cilia Forceps Splitter und Clienpinzetten

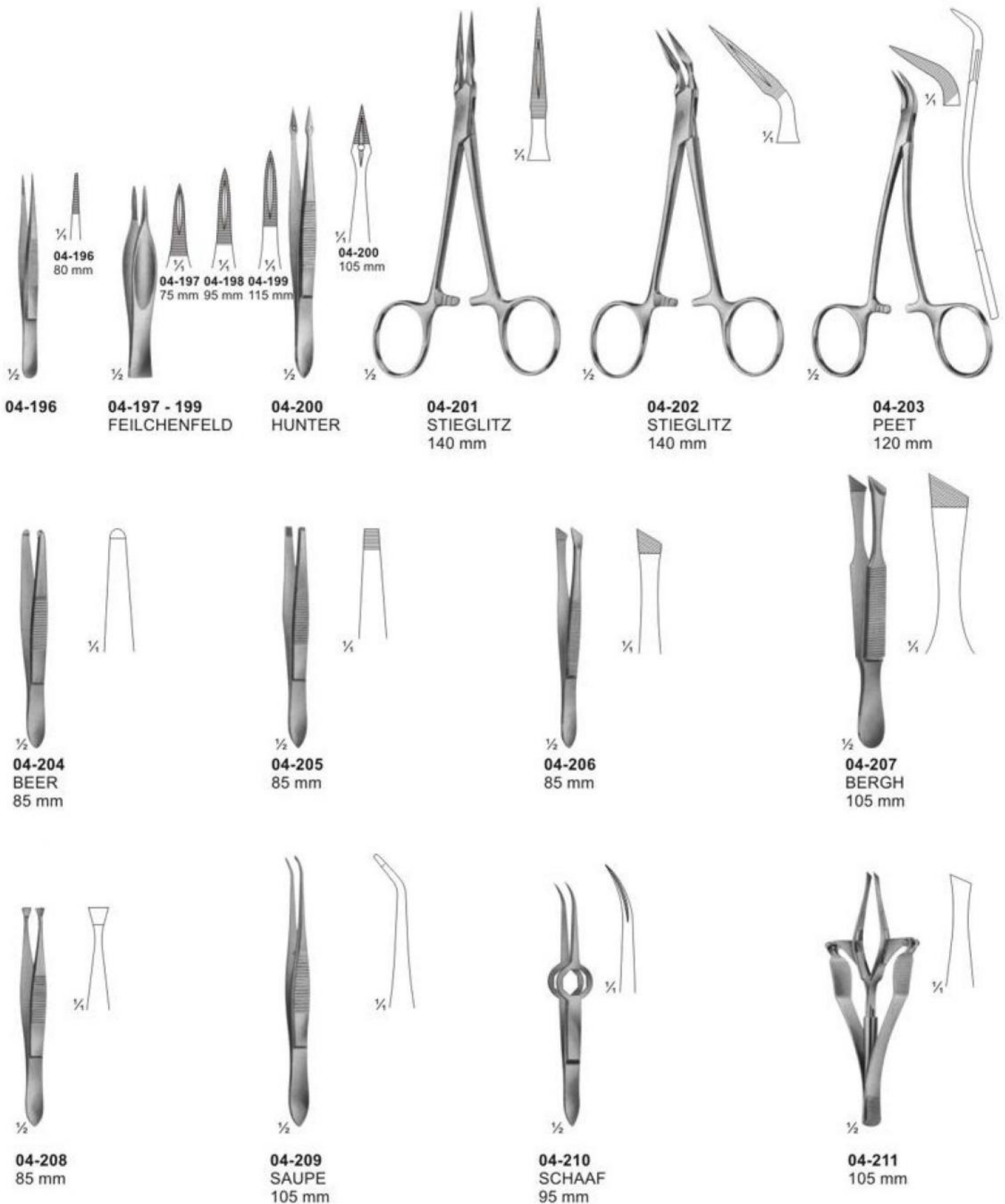



05-147 130 mm
05-148 145 mm
05-149 160 mm
Directors



05-150
DOYEN
145 mm
Directors



05-151
NELATON
160 mm
Directors



05-152
Director with tip
Diam. Of tip 3,3 mm
140 mm



05-153
BRODIE
Director with tip,
Diam. Of tip 3,5 mm
200 mm

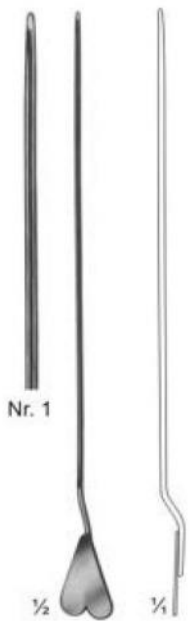

Nr. 1
05-154
LOCKHART-MUMMERY
165 mm

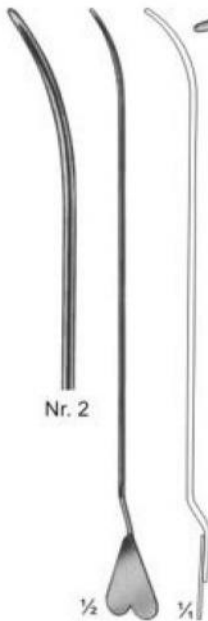

Nr. 2
05-155
LOCKHART-MUMMERY
165 mm

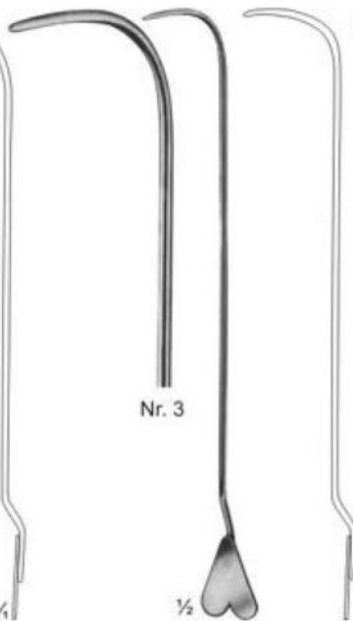

Nr. 3
05-156
LOCKHART-MUMMERY
165 mm

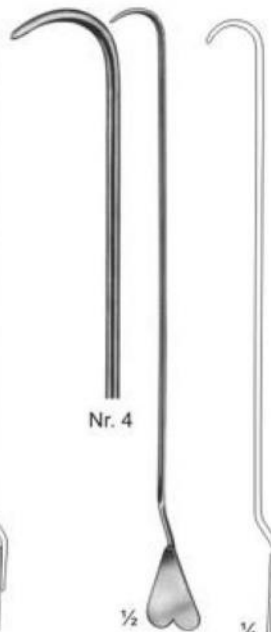

Nr. 4
05-157
LOCKHART-MUMMERY
165 mm



05-158
Director with wire
loop, malleable
190 mm



05-147 130 mm
05-148 145 mm
05-149 160 mm
Directors



05-150
DOYEN
145 mm
Directors



05-151
NELATON
160 mm
Directors



05-152
Director with tip
Diam. Of tip 3,3 mm
140 mm

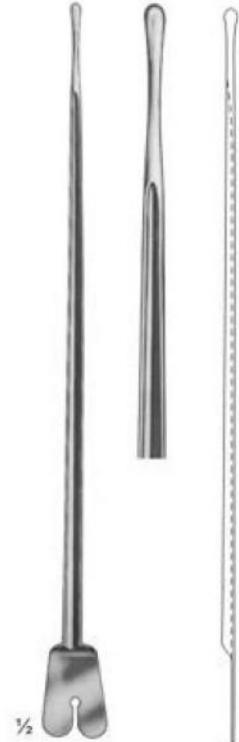

05-153
BRODIE
Director with tip,
Diam. Of tip 3,5 mm
200 mm

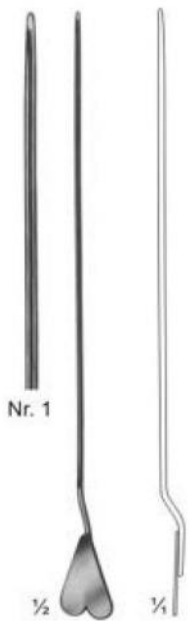

05-154
LOCKHART-MUMMERY
165 mm

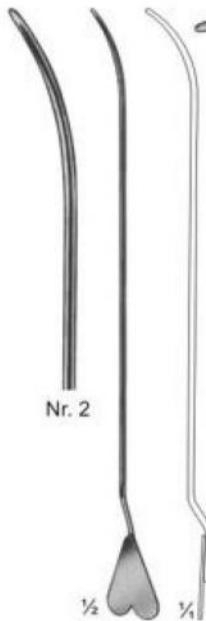

05-155
LOCKHART-MUMMERY
165 mm

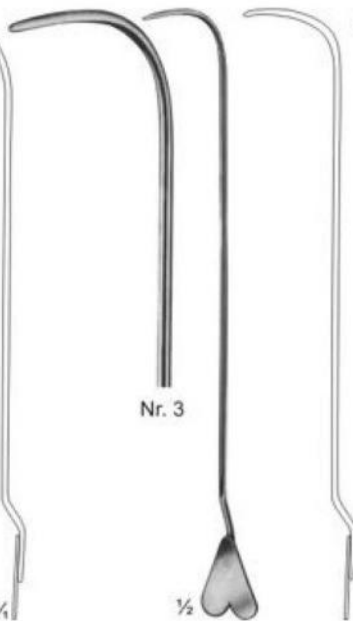

05-156
LOCKHART-MUMMERY
165 mm

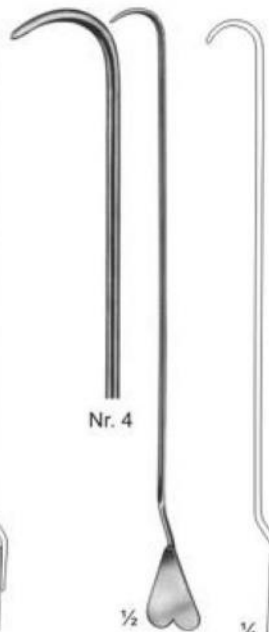

05-157
LOCKHART-MUMMERY
165 mm



05-158
Director with wire
loop, malleable
190 mm



Bone Retractors and Retractors Knochen- und Wundhaken



06-169
KOCHER
sharp
205 mm



06-170
KOCHER
sharp
220 mm



06-171
KOCHER
sharp
220 mm



06-172
VOLKMANN
blunt
220 mm



06-173
VOLKMANN
sharp
220 mm



06-174 - 181
VOLKMANN
225 mm

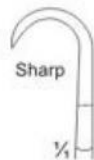

06-174
9 x 8 mm



06-175
9 x 13 mm



06-176
9 x 19 mm



06-177
9 x 29 mm



06-178
8,5 x 8 mm



06-179
8,5 x 13 mm



06-180
8,5 x 19 mm



06-181
8,5 x 29 mm

Retractors Wundhaken

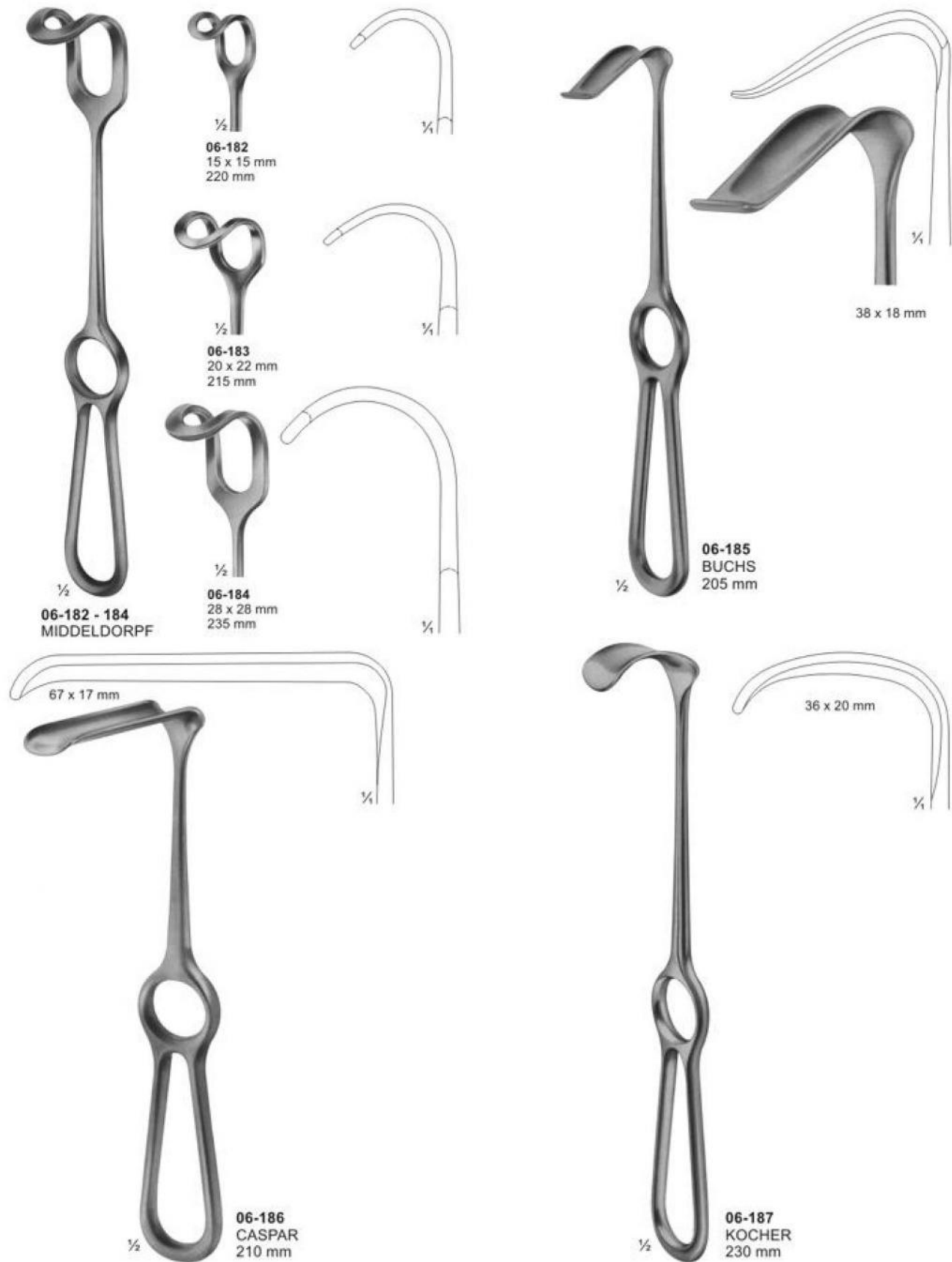

Retractors, Vario Retractor System
Wundhaken, Vario- Wundhaken-System



- 06-188 - 194**
BRUNNER
 275 mm
- 06-188 80 x 20
 - 06-189 100 x 25
 - 06-190 120 x 25
 - 06-191 130 x 30
 - 06-192 140 x 30
 - 06-193 160 x 30
 - 06-194 180 x 30

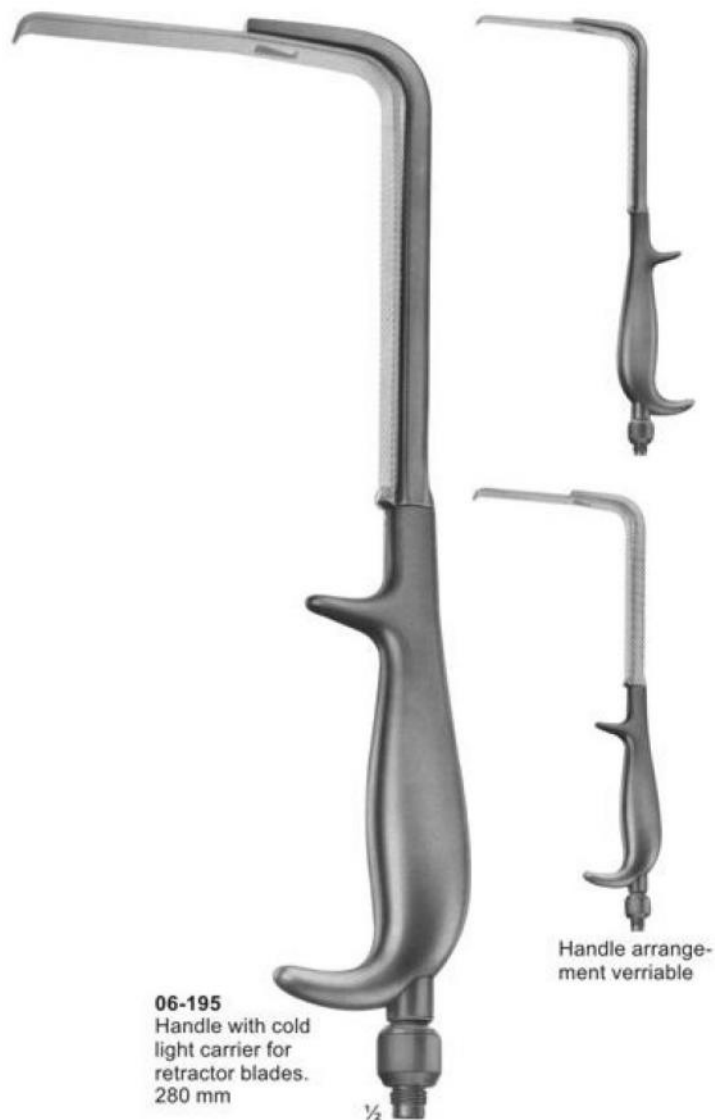

06-195
 Handle with cold
 light carrier for
 retractor blades.
 280 mm

Handle arrange-
 ment verriable

Retractors, Lung Spatulas
Wundhaken, Lungenspatel



Retractors for deep surgery (Abdominal Retractors)
Wundhaken für Eingriffe in der Tiefe (Bauchdeckenha

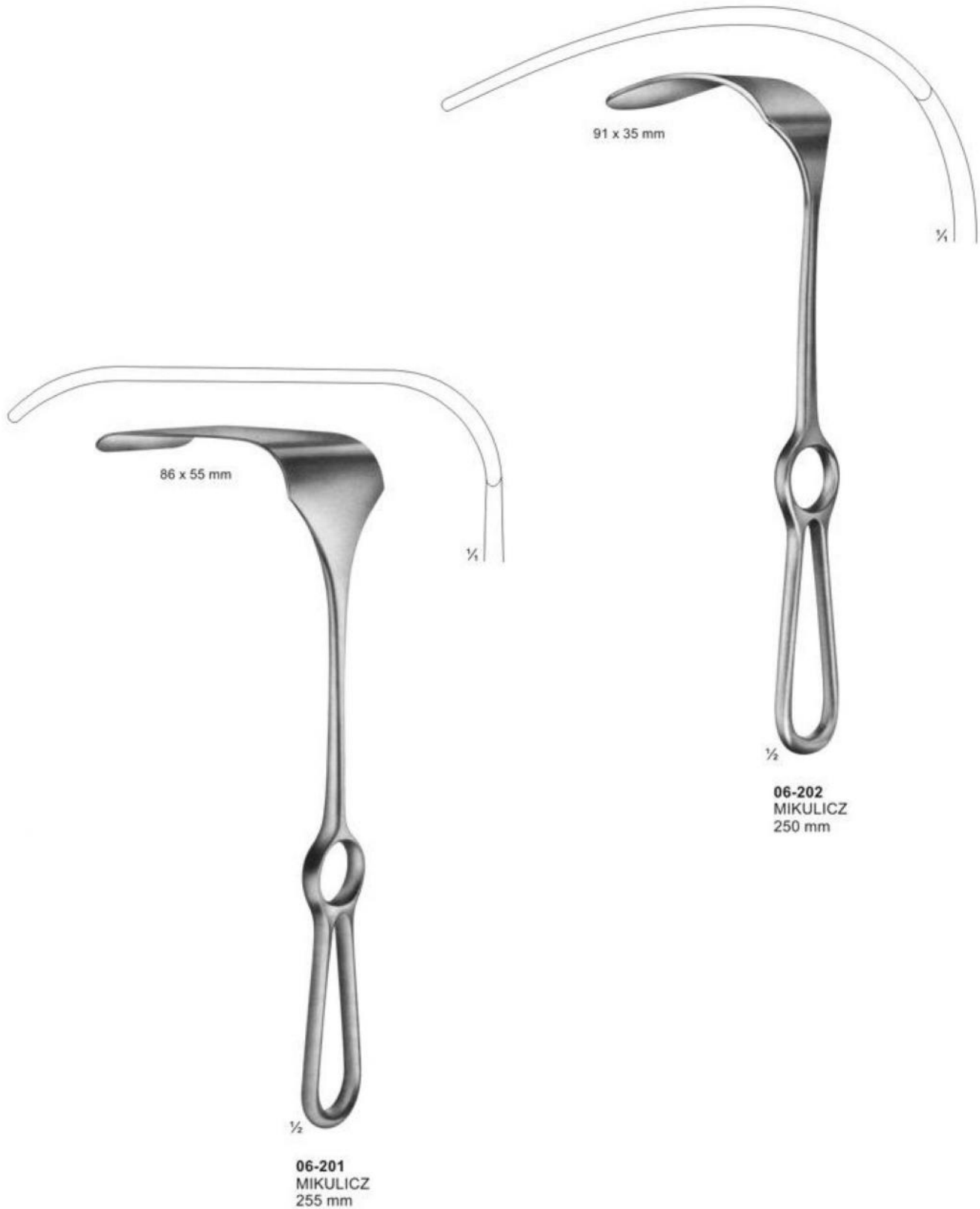

Retractors, Abdominal Retractors Wundhaken, Bauchdeckenhaken



	width of blades	
	35 mm, 45 mm, 60 mm	
length of blades		
62 mm	06-203, 06-204, 06-205	
92 mm	06-206, 06-207, 06-208	
122 mm	06-209, 06-210, 06-211	
160 mm	06-212, 06-213	

Abdominal- and Intestinal Spatulas
Bauch- und Darmspatel



06-220
LERICHE
 255 mm

06-221
KUMMEL
 Mealleable
 285 mm

06-222
MIKULICZ
 29 mm
 250 mm

06-223 - 224
KADER
06-223 30 mm
06-224 40 mm
 270 mm